

1

yuwell

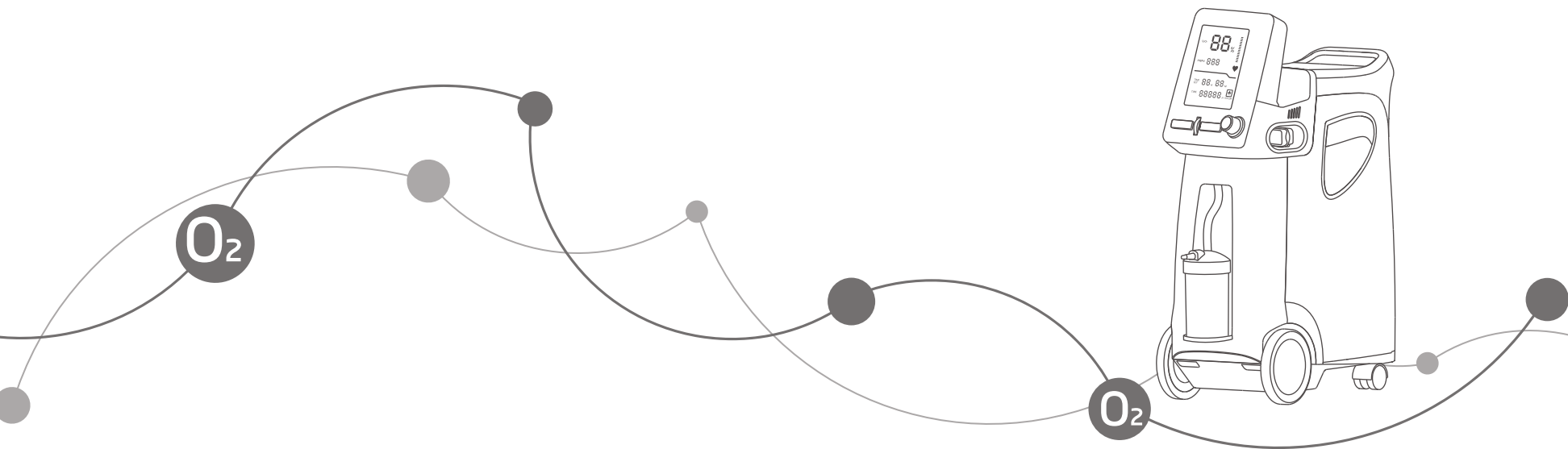

9F-3A/9F-3AW Oxygen Concentrator

User's Manual

JIANGSU YUYUE MEDICAL EQUIPMENT & SUPPLY CO., LTD.

Sales Center Address: Huanyuan East Road No.1, Xuzhuang Software
Park, Nanjing, Jiangsu Province, P.R. China, 210000

Manufacturing Address: No.1 Baisheng Road, Development Zone, Danyang City
Jiangsu Province, China.

<http://www.yuwell.com>



Please read the user's manual closely before using!

TABLE OF CONTENTS

SAFETY NOTES-----01-05

FEATURES-----05-06

HANDLING-----07-07

OPERATING & INSTALLATION-----07-14

MAINTENANCE-----14-16

TROUBLE SHOOTING GUIDE -----17-19

OTHER ATTENTION ITEMS-----20-21

SAFETY NOTES

WARNING: For avoiding power outage or oxygen concentrator operating failure, exigent oxygen user and serious patient must equip with reserve oxygen supply (for example: oxygen cylinder, oxygen bag). This device is to be used as an oxygen supplement and is not considered life supporting or life sustaining.

BEFORE INSTALLATION

- The concentrator should always be kept in the upright to prevent cabinet damage when transporting.
- When the electrical source, power voltage is beyond the normal power voltage range. Please add voltage stabilizer.
- Use eligible, safe power set and junction box.
- Only the technician can open the oxygen concentrator's cabinet.

STORAGE PLACE

- You may select the most suitable room when using your oxygen concentrator. Use the casters to transfer the concentrator from room to room.
- Place the unit away from all sides for at least 10cm (4inches) from walls, draperies, furniture, or other obstruction. Do not place the unit in a confined area.
- Oxygen concentrator must avoid from heat, fire, moisture, exorbitant or over-low extreme condition.
- Sundries and vessel should not be placed on top of the concentrator.
- NEVER block the air inlet of the unit or place it on a soft surface, such as a bed or couch, where the air inlet may be blocked. Keep the inlet free from lint, hair ,etc.

USING

- The use of oxygen therapy requires that special attention to reduce the risk of fire. Users **MUST NOT SMOKE** while using this device. Keep all matches, lighted cigarettes or other sources of ignition out of the room in which this product is located. **NO SMOKING** signs should be prominently displayed. Textiles and other materials that normally would not burn are easily ignited and burn with great intensity in oxygen enriched air. Failure to observe this warning can result in severe fire, property damage and cause physical injury or **DEATH**.
- For optimum performance, do not open or turn off the concentrator frequently, reset after 3~ 5 minutes. Shorter periods of operation may reduce maximum product life.
- A spontaneous and violent ignition may occur if oil, grease or greasy substances come in contact with oxygen under pressure. These substances **MUST** be kept away from the oxygen concentrator, tubing and connections, and all other oxygen equipment. **DO NOT** use any lubricants unless recommended by manufacturer.

MAINTENANCE

Only the authorized or trained technician can perform the maintenance or adjustments to the oxygen concentrator. The manufacturer recommends each operation time should not be less than 30 minutes, do not frequently press the switch in order to extend the operation life to the machine.

RADIO FREQUENCY INTERFERENCE

Most electronic equipment is influenced by Radio Frequency Interference (RFI). **CAUTION** should be exercised with regard to the use of portable communications equipment in the area around such equipment.

TO REDUCE THE RISK OF BURNS, ELECTROCUTION, FIRE OR INJURY TO PERSONS

- Avoid using while bathing. If continuous usage is required by the doctor's prescription:
The concentrator must be located in another room at least 2.5m away from the bath.
- Do not come in contact with the concentrator while wet.
- Do not place or store product where it can drop into water or other liquid.
- DO NOT contact the product that has fallen into water. Unplug immediately.
- A product should never be left unattended when plugged in.
- This device is to be used only in accordance with the prescription of a doctor and this user's manual. If at any time the patient or attendant conclude that the patient is receiving an insufficient amount of oxygen, the supplier and/or doctor should be contacted immediately. No adjustments should be made to the flowrate unless prescribed by a doctor.
- Close supervision is necessary when this product is used near children or individuals with disability.
- Use this product for only intended use as described in this manual.
- Do not use parts, accessories or adapters other than those authorized by manufacturer.
- Do not connect the concentrator with other oxygen concentrators or oxygen therapy devices.
- Use of some administration accessories or certain humidifiers not specified for use with oxygen concentrator may impair the performance.
- In certain circumstances oxygen therapy can be hazardous. Manufacturer recommends that you seek medical advice before

using this product.

- Avoid creation of any spark near medical oxygen equipment. This includes sparks from static electricity created by any type of friction.

FEATURES

SUMMARY

The function of oxygen

- Supplying oxygen to patients can assist in the treatment of heart head blood-vessel, respiratory system, such as chronic obstructive pneumonia disease, rehabilitation and hypoxia conditions.
- Oxygen could improve body function, especially suit for elderly, pregnant women, physique, students etc. Who got physiological hypoxia. It may also reduce fatigue after heavy manual or mental consumption.

THE SCOPE OF PRODUCTS

For hospital and homecare to supply oxygen to patients.

STRUCTURE

- The product is mainly composed of oxygen making host, flow meter, humidifier.
- Safety plastic shell.
- With time collect function: Display the operation time in LCD.
- With timing power off function.
- High and low pressure alarm function.
- Power loss alarm function.
- Fault self-detection system(Include pressure fault, system cycle fault, compressor fault).

- ▶ The compressor with thermal protector guarantee better security.
- ▶ *With nebulizer function.(9F-3AW)

SPECIFICATIONS

1. Maximum recommended flow: 3L/min
2. Flow Range: 0.5 ~ 3L/min
3. Change in maximum recommended flow when back pressure of 7kPa is applied: 0.5L/min
4. Oxygen Concentration: 93% ± 3%
5. Maximum Outlet Pressure: 20 ~ 50kPa(2.9psi~7.25psi)
6. Graph showing values of oxygen concentration as a function of flowrate at a nominal outlet pressure of zero (Figure 1):

Oxygen Concentration: %

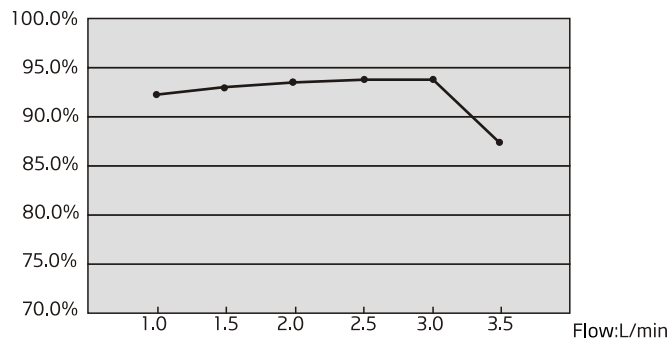

Figure 1

7. Pressure Relief Mechanism Operational at:
250kPa ± 25kPa (36.25psi ± 3.63psi)
8. Noise: ≤46dB(A)
- *9. Maximum Nebulization Rate: ≥0.15mL/min(9F-3AW)
10. Power Supply:
 AC100V ± 10% AC120V ± 10% AC220V ± 10% AC230V ± 10%
 50Hz 60Hz
11. Input Power: 320VA

12. Weight: 16.5kg

13. Dimension: H64cm (25.2") x W24cm (9.5") x D49cm (19.3")

14. Altitude: Up to 1828 meters (6000 ft) above sea level without degradation of concentration levels. From 1828 meters (6000 ft) to 4000meters (13129 ft) below 90% efficiency.

15. Safety system:

Current overload or loose connection, automatic shutdown;
 Compressor with abnormal high temperature, automatic shutdown;
 High & low pressure alarm function, automatic shutdown;
 Compressor error function, automatic shutdown;

16. Minimum Operating Time: 30minutes

17. Electric classification: Class II , type BF application part

18. Work system: work continuously.

19. NORMAL OPERATION CONDITIONS:

Temperature range: 10°C ~ 35°C (50°F ~ 95°F);

Relative humidity: 30% ~ 75%;

Atmosphere pressure: 860hPa ~ 1060hPa(12.47psi ~ 15.37psi);

NOTE: When storage temperature is below 5°C, please keep the equipment in normal working condition for at least 4 hours before using.

20. Temperature at oxygen outlet: ≤46°C

21. Suggestion: The length of nasal oxygen cannula should be less than 15.2 meters and should not be pinched.

22. Transportation and storage conditions :

Temperature range: -20°C ~ +60°C(-4°F ~ 140°F),

Relative humidity: 10% ~ 93%, no condensation,

Atmosphere pressure: 700hPa ~ 1060hPa(10.15psi ~ 15.37psi).

NOTE: Oxygen concentrator should be stored with out intense sunlight, no corrosive gas and in a well ventilated room, avoid jolt and inverted recumbent transport.

HANDLING

UNPACKING

⚠ NOTE: Unless the oxygen concentrator is to be used immediately, otherwise it should be stored in the containers until it's being used again.

- Check for any obvious damage to the carton or its contents. If damage is evident, please notify the carrier or local dealer.
- Remove all loose packing from the carton.
- Carefully remove all the components from the carton.

INSPECTION

- Examine exterior of the oxygen concentrator for nicks, dents, scratches or other damages. Inspect all components.

STORAGE

- Store the repackaged oxygen concentrator in a dry area.
- Do not place other objects on top of the repackaged concentrator.

OPERATING & INSTALLATION

FEATURE VIEW

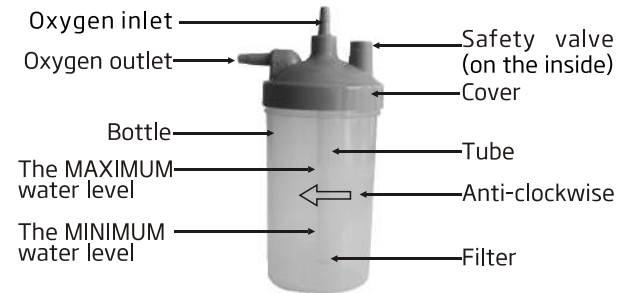
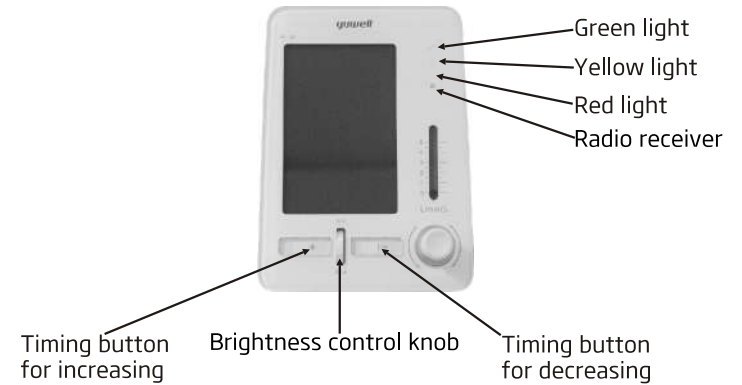
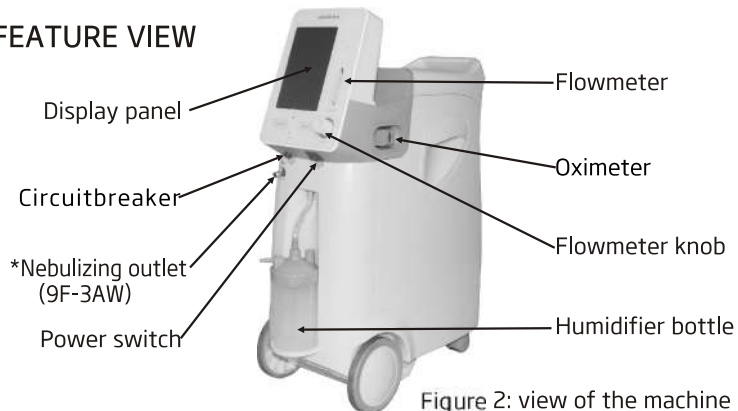

PREPARE WORK

- Unscrew the bottle from the humidifier clockwise. Fill the bottle with pure water (or distilled water) to the level indicated by the manufacturer.
- Screw securely to the bottle back clockwise.
- Plug in: First confirm the power switch of oxygen concentrator is off, then connect the plug .
- Do not use extended power line.

OXYGEN ABSORBING OPERATION

- ▶ Turn the power switch to " | " , the LCD shows "HELLO" , Green, yellow, red indicator all light indicates that the machine is normal. The green indicator lights only 1 second later. 4 seconds later, the LCD shows elapsed time and time setting interface "--", then the machine goes to normal operation.

- ▶ Turn the flowrate knob to require oxygen need (Reed as centre of the black ball). Turn the knob anticlockwise to increase the flowrate, and clockwise to decrease. Meanwhile, humidifier bottle will have air bubble around the sieve core. Then, oxygen comes from the oxygen outlet. (Figure 5)

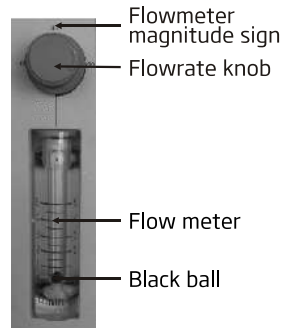

Figure 5

- ▶ Connect the nasal oxygen cannula to the oxygen outlet of the humidifier, the other end match the patient.

⚠ Note: Adjust the time of absorbing oxygen and the flowrate range according to the doctor's advices.

- ▶ If the humidifier makes continuous sound, it shows that the nasal oxygen cannula jammed, then please clear the pipeline.
- ▶ CAUTION: If the flowrate on the flowmeter ever falls below 0.5L/min, check tubing or accessories for blocked or kinked tubing or a defective humidifier bottle.

*NEBULIZING OPERATION(9F-3AW)

- ▶ Fill proper medicinal liquid in the nebulizing cup (Please follow the doctor's advices for nebulizing time or don't exceed the maximum scale of the nebulizing cup).
- ▶ Upward pull out the nebulizing cover on the nebulizing interface. (Figure 6)

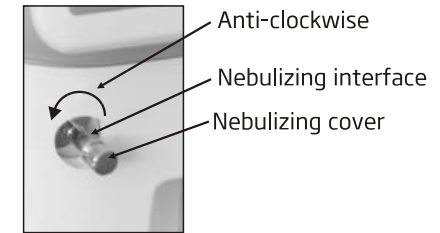





Figure 6

- ▶ Connect the air hose to neblizing cup and nebulizing interface, then turn on the power of the oxygen concentrator, now can begin nebulizing cure immediately.
- ▶ NOTE: the time for nebulizing should follow the doctor's advices.
- ▶ When nebulizing completing, please turn the nebulizing cover right to nebulizing interface for tightening. When the treatment finishes, please turn off the oxygen concentrator.
- ▶ Screw the nubilizing cover when finished.

Fault detection and alarm signal

- ▶ The machine has detection function as follows
 - (1)Pressure, cycle failure
 - (2)Compressor failure
 - (3)Low oxygen concentration
- ▶ Remarks: All alarm state of the oxygen concentrator belongs to low priority.
- ▶ The oxygen sensor starts working after 5 minutes of operation. The indicator shows different colours on the basis of different ranges of oxygen concentration.
Indicator interpretation

Symbol	Statement	Indicator
I/O	System is in good condition: oxygen concentration $\geq 82\%(+3\%)$	Green
	oxygen concentration $< 82\%(+3\%)$	Yellow
	1)Pressure, cycle failure alarm 2)Compressor failure alarm	Red

- The alarm signal
 1. When oxygen concentration $\geq 82\%(+3\%)$ the green indicator lights, LCD shows " elapsed time --", the machine is in good condition.
 2. When oxygen concentration $< 82\%(+3\%)$ the yellow indicator light , LCD shows "elapsed time --", Please contact the supplier immediately. Users can continue to use, and please ensure that backup oxygen is nearby.
-  **NOTE:** The minimum operating time is 30 minutes
- 3. Pressure, cycle failure alarm--the red indicator lights with continuous alarm sound, LCD shows "E1 or E2" machine stops working. Please shut down immediately and use backup oxygen, and contact the supplier immediately.
- 4. Compressor failure alarm--the red indicator lights with continuous alarm sound, LCD shows "E3 or E4", machine stops working. Please shut down immediately and use backup oxygen, and contact the supplier immediately.
- 5. Power loss alarm--alarm sound, no display, no machine working. Please check the power input.

TIME SETTING











This machine has timer function, users can set in the range of 00 ~ 99 minutes.

- When LCD shows "--" it means continuous operation state.
- Every time press the "+", means runtime increases 1 minute, press for more than 1 .5 seconds for continuous increasing."
- Every time press the "-", means runtime decreases 1 minute, press for more than 1 .5 seconds for continuous decreasing.
- The oxygen concentrator will automatically shut down meanwhile LCD shows "0" when time runs out.

TURNNING OFF

Take off nasal oxygen cannula from oxygen outlet first, close power switch, and then cut off power source.

SYMBOLS

Symbol	Description	Symbol	Description
	Alternating current		Consult the manual
	Class II Equipment		Type BF Applied part
	OFF(power, disconnection from the mains)		ON(power, connection to the mains)
	NO SMOKING		KEEP UP
	FRAGILE		KEEP DRY

USING METHOD OF REMOTE CONTROL

- The remote has same functions with the buttons on the machine. (Figure 7)

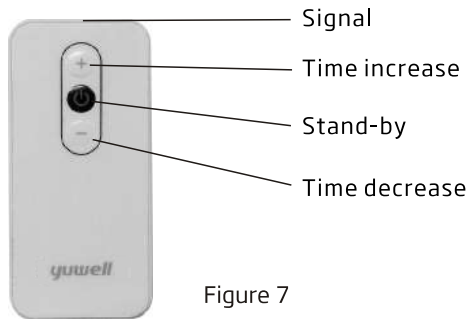

Note: Please use the remote control in front of the receiver.

USING METHOD OF OXIMETER

- Pull out the oximeter from the right side of machine. (Figure 8)
- Flip the tail, then insert a finger. (Figure 9, Figure 10)

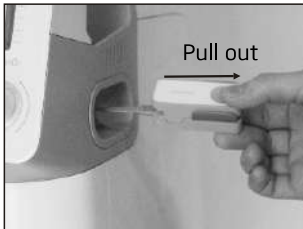

- Read the result in about 10 seconds.

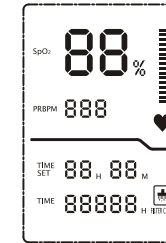

- After monitoring, pull once more the oximeter to replace it.
- Clean & disinfection

⚠ Caution: Please turn off the machine before cleaning.
Clean the oximeter once a week with clean and soft cloth which with diluted soapy water.

MAINTENANCE

⚠ WARNING: CUT OFF the power supply first. To avoid electrical shock, DO NOT removes cabinet.

CLEANING CABINET

- Clean the cabinet with a mild household cleaner and non-abrasive cloth or sponge at least one time each month.

CLEANING OR REPLACING FILTERS

- Please clean and replace the filters in time, it's very important to protect compressor and delay machine's life.
- ⚠ CAUTION: DO NOT operate the concentrator without the filters installed.
- The mesh in filter cleans once half a month. I -stage filter can be taken out of the foreside panel. (Figure12、 Figure13)

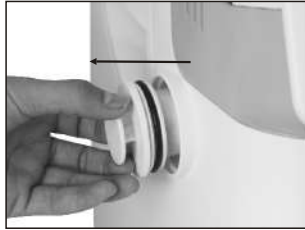

Figure 12



Figure 13

The filter is in the left side of the machine, you can pull out it directly.

1) Clean the filters with a vacuum cleaner or wash in warm soapy water and rinse thoroughly.

2) DRY the filters thoroughly before reinstallation.

- Damage: Do not operate the concentrator without the filters installed, or while filters are wet. These actions could permanently damage to the concentrator.

CLEANING HUMIDIFIER

- Change the water in humidifier bottle every day.
- Clean humidifier once a week with soapy water and rinse it with a solution of water and vinegar(10:1). Rinse thoroughly with warm water and refill with pure water (or distilled water) to the level shown on the humidifier. (NOTE: No blobs in oxygen tubing)
- Disassembly
 - (1) Screw off the bottle. (Figure14).
 - (2) Take out of the core tube and sieve core. (Figure15).



Figure 14



Figure 15

*CLEANING NEBULIZING ASSEMBLY(9F-3AW)

- Clean the nebulizing assembly after using each time.
- Pull out the air hose, pull the mouthpiece, downward pull the nebulizing cup's cap, empty remained medicinal liquid in the nebulizing cup, then wash the air hose, mouthpiece, nebulizing cup's cap, nebulizing baffle, nebulizing cup, ripple tube, T-piece, etc , with pure water or immerge them in warm water for about 15 minutes(Figure 16). In order to wash them properly, you may add some vinegar in water.
- ⊙ NOTE: DO NOT cook the accessories above for wash or wash them with boiled water, in case they'll distort when heating.
- After finishing washing you must dry all the accessories before storing.

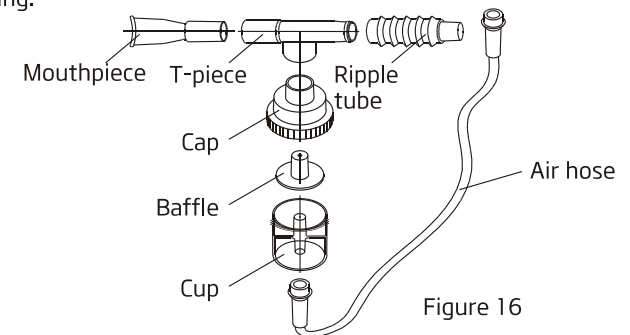

Figure 16

TROUBLE SHOOTING GUIDE

Symptom	Probable reasons	Solution	Remark
Press the switch, the concentrator is alarm of continuous buzzer but no display and working.	1)Power cord NOT plugged in	1)Insert plug into outlet	Repairs by qualified personnel
	2)No power at outlet	2)Use normal power	
	3)The power is no sufficient at outlet	3)Do not use extended cord	
	4)Raise circuit breaker	4)Press it. If this state continues, stop using the concentrator and get in touch with the supplier at once.	
Concentrator is working, but oxygen from outlet is little or no	1)Humidifier leaked	1)Reinstall and tighten it	
	2)Safety valve of humidifier opens	2)Safety valve restoration	
	3)The connection of the tubes loosened	3)Insert tubes	
	4)The nasal cannula kinked or blocked	4)Replace it	
Concentrator is working, green with yellow light illuminate	1)oxygen concentration < 82%	1)Clean or replace the filter	
	2)Oxygen flow rate is more than 3L/min	2)Compiled doctor's advice, turn the flowmeter to the given value	
	3)If this state continues, you may continue to use the concentrator. Contact the supplier at once.		
Concentrator is alarm and not working, the red light illuminate, the display screen shows "E1"	1)Low cycle pressure failure	1)Clean or replace the stage filter	
	2)If this state continues, stop using the concentrator and get in touch with the supplier at once.		

Symptom	Probable reasons	Solution	Remark
Concentrator is alarm and not working, the red light illuminate, the display screen shows "E2"	1)High cycle pressure failure	1)Stop using the concentrator and get in touch with the supplier at once	
Concentrator is alarm and not working, the red light illuminate, the display screen shows "E3"	1)Compressor circuit is open circuit	1)Stop using the concentrator and get in touch with the supplier at once	
Concentrator is alarm and not working, the red light illuminate, the display screen shows "E4"	1)Compressor circuit is short circuit	1)Stop using the concentrator and get in touch with the supplier at once	
The nasal cannula has more mirage or blobs	1)It's not ventilate completely around machine, so operating temperature is too high	1)Make sure the machine is at least 10cm away from the walls, other jam or heater	
	2)Temperature of the water added in humidifier bottle is overhigh	2)Add cold water in bottle, but don't add overhot water	
	3)The water added in humidifier bottle is too much	3)Make sure the water stays between the maximum and minimum of the water scale	
	4)The machine stops suddenly during breathing oxygen	4)Stop breathing oxygen immediately. Restart the machine to eject the hydrosphere	
	5)The machine stops suddenly when folding the nasal cannula	5)Smooth the nasal cannula	
	6)Fan inside the machine can't run or running rate turns slow make the operating temperature overhigh	6)a.Take out the eyewinker that lock the fan 6)b. Replace it	Repairs by qualified personnel

Symptom	Probable reasons	Solution	Remark
*The nebulizer doesn't run (9F-3AW)	1)Check nebulizer is distortional or not if it was disinfected.	1)Replace it	
	2)Check the air hose whether it is bended or not	2)Ensure that it isn't bended and airflow is flowed smoothly when it is used	
	3)Check whether medication was used up or not	3)Add appropriate amount medicine to cup	
	4)Check the nebulizer is fixed properly or not	4)Fix it according the method of nebulizer's fixing	
Show result of SpO2 or Pulse rate is not stable	1)Some foreign object shielded the probe from light	1)Check the probe and clean it	
	2)Finger is shaking or body is moving	2)Stay still	
	3)Finger has not inserted properly	3)Make sure the center of finger is matched the oximeter	
	4)Glare	4)Shield the oximeter with opaque goods	
	5)Pulse rate is cyclic swing	5)Arrhythmia	
	6)Please do not use the oximeter and contact with the supplier		
Oximeter does not show result correctly	1)Finger has not inserted properly	1)Make sure the center of finger is matched the oximeter	
	2)For fingers with nail-polish	2)Remove nail-polish	
	3)SpO2 is too low or pulse rate is irregular	3)Test for several times to check the machine. Or please see a doctor	
	4)If the problem continuous, please contact the supplier		
Remote control doesn't work	1)The remote control is not in effective range	1)Please use the remote control in effective range	
	2)Low power	3)Please change with new batteries	

⚠ If you have all other problems, TURN OFF the concentrator first, use your reserve oxygen supply (if provided) and contact dealer or manufacturer immediately.

OTHER ATTENTION ITEMS

GAS PASS OPERATION SKETCH MAP

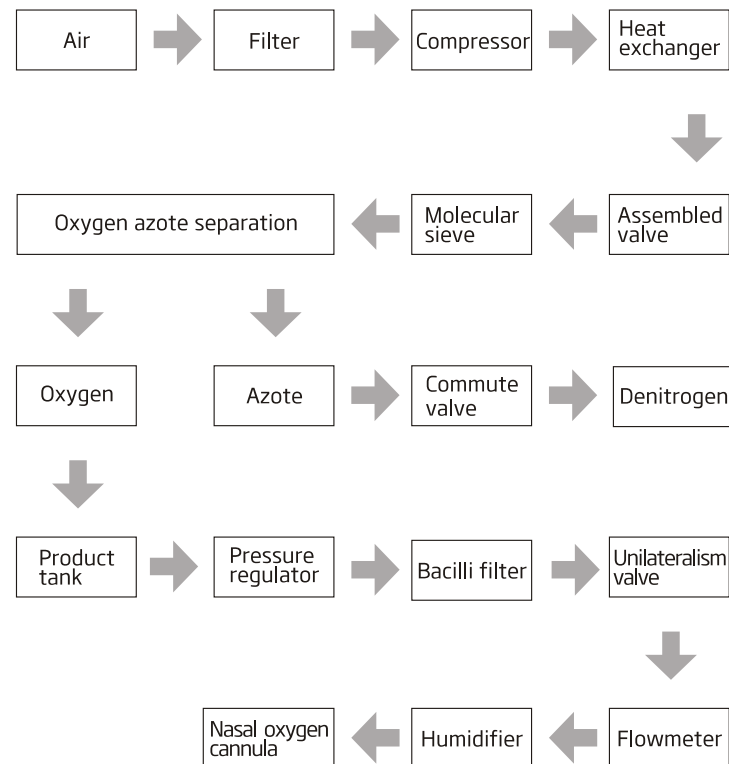

ELECTRICAL RATIONALE

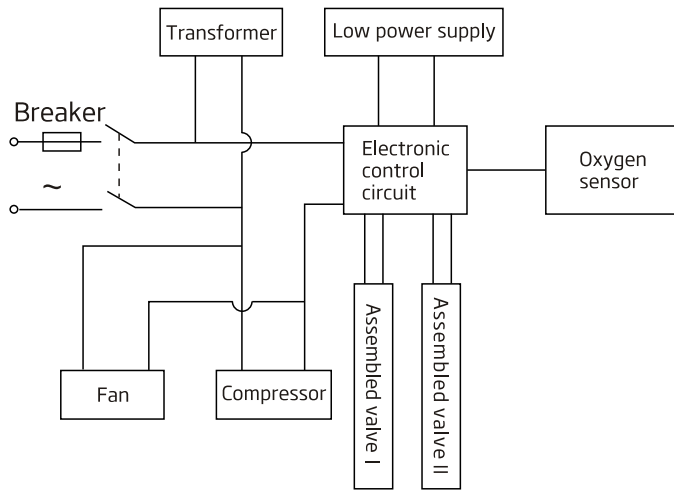

ACCESSORIES LIST

1. Nasal oxygen cannula	1 set
2. User's and Technical manual	1 piece
3. Filter core	1 set
*4. Nebulizer (9F-3AW)	1 set
5. Remote control	1 set

JIANGSU YUYUE MEDICAL EQUIPMENT & SUPPLY CO., LTD
 江苏鱼跃医疗设备股份有限公司
 说明

△ All specifications and product configurations are subject to change without notification.

yuwell

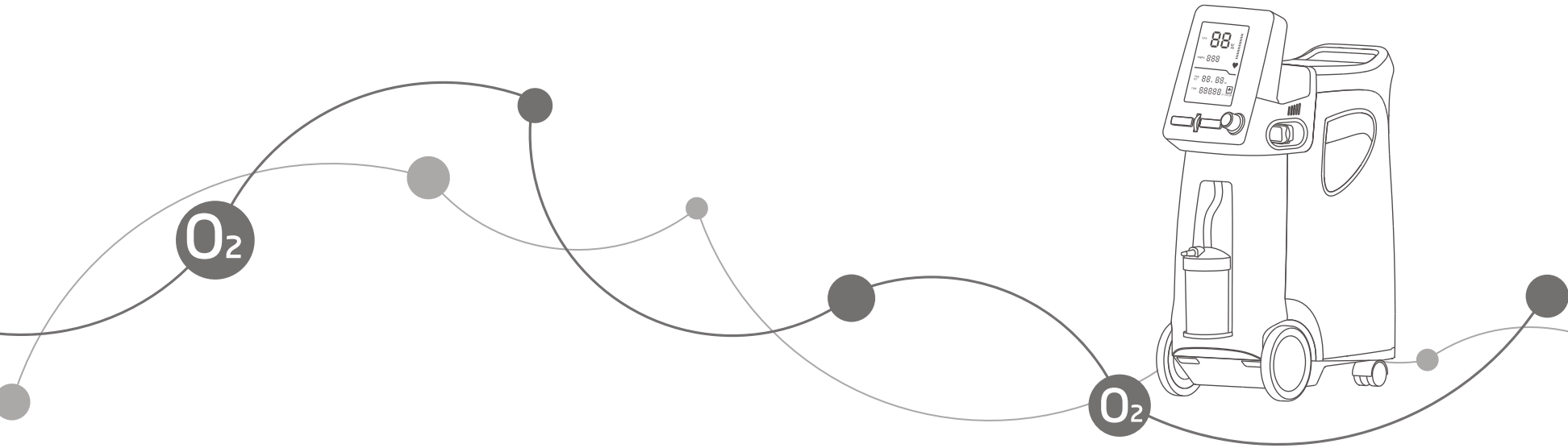

9F-5AW

Oxygen Concentrator

User's and Technical Manual

JIANGSU YUYUE MEDICAL EQUIPMENT & SUPPLY CO., LTD.

Sales Center Address: Huanyuan East Road No.1, Xuzhuang Software Park, Nanjing, Jiangsu Province, P.R. China, 210000

Manufacturing Address: No.1 Baisheng Road, Development Zone, Danyang City

Jiangsu Province, China.

<http://www.yuwell.com>

Please read the user's manual closely before using!

TABLE OF CONTENTS

SAFETY NOTES-----01-04

FEATURES-----04-06

HANDLING-----07-07

OPERATING & INSTALLATION-----07-14

MAINTENANCE-----14-16

TROUBLE SHOOTING GUIDE -----17-19

DISASSEMBLY-----20-22

OTHER ATTENTION ITEMS-----23-24

SAFETY NOTES

WARNING: For avoiding power outage or oxygen concentrator operating failure, exigent oxygen user and serious patient must equip with reserve oxygen supply (for example: oxygen cylinder, oxygen bag). This device must equip with reserved oxygen supply and is not used as life supporting or life sustaining.

BEFORE INSTALLATION

- The concentrator should always be kept in the upright to prevent cabinet damage when transporting.
- When the electrical source, power voltage is beyond the normal power voltage range. Please add voltage stabilizer.
- Use eligible, safe power set and junction box.
- Only the technician can open the oxygen concentrator's cabinet.

STORAGE PLACE

- You may select the most suitable room when using your oxygen concentrator. Use the casters to transfer the concentrator from room to room.
- Place the unit away from all sides for at least 10cm (4inches) from walls, draperies, furniture, or other obstruction. Do not place the unit in a confined area.
- Oxygen concentrator must avoid from heat, fire, moisture, exorbitant or over-low extreme condition.
- Sundries and vessel should not be placed on top of the concentrator.
- NEVER block the air inlet of the unit or place it on a soft surface, such as a bed or couch, where the air inlet may be blocked. Keep the inlet free from lint, hair ,etc.

USING

- The use of oxygen therapy requires that special attention to reduce the risk of fire. Users **MUST NOT SMOKE** while using this device. Keep all matches, lighted cigarettes or other sources of ignition out of the room in which this product is located. **NO SMOKING** signs should be prominently displayed. Textiles and other materials that normally would not burn are easily ignited and burn with great intensity in oxygen enriched air. Failure to observe this warning can result in severe fire, property damage and cause physical injury or **DEATH**.
- For optimum performance, do not open or turn off the concentrator frequently, reset after 3~ 5 minutes. Shorter periods of operation may reduce maximum product life.
- A spontaneous and violent ignition may occur if oil, grease or greasy substances come in contact with oxygen under pressure. These substances **MUST** be kept away from the oxygen concentrator, tubing and connections, and all other oxygen equipment. **DO NOT** use any lubricants unless recommended by manufacturer.

MAINTENANCE

Only the authorized or trained technician can perform the maintenance or adjustments to the oxygen concentrator. The manufacturer recommends each operation time should not be less than 30 minutes, do not frequently press the switch in order to extend the operation life to the machine.

RADIO FREQUENCY INTERFERENCE

Most electronic equipment is influenced by Radio Frequency Interference (RFI). **CAUTION** should be exercised with regard to the use of portable communications equipment in the area around such equipment.

TO REDUCE THE RISK OF BURNS, ELECTROCUTION, FIRE OR INJURY TO PERSONS

- Avoid using while bathing. If continuous usage is required by the doctor's prescription:
The concentrator must be located in another room at least 2.5m away from the bath.
- Do not come in contact with the concentrator while wet.
- Do not place or store product where it can drop into water or other liquid.
- DO NOT contact the product that has fallen into water. Unplug immediately.
- A product should never be left unattended when plugged in.
- This device is to be used only in accordance with the prescription of a doctor and this user's manual. If at any time the patient or attendant conclude that the patient is receiving an insufficient amount of oxygen, the supplier and/or doctor should be contacted immediately. No adjustments should be made to the flowrate unless prescribed by a doctor.
- Close supervision is necessary when this product is used near children or individuals with disability.
- Use this product for only intended use as described in this manual.
- Do not use parts, accessories or adapters other than those authorized by manufacturer.
- Do not connect the concentrator with other oxygen concentrators or oxygen therapy devices.
- Use of some administration accessories or certain humidifiers not specified for use with oxygen concentrator may impair the performance.
- In certain circumstances oxygen therapy can be hazardous. Manufacturer recommends that you seek medical advice before

using this product.

- Avoid creation of any spark near medical oxygen equipment. This includes sparks from static electricity created by any type of friction.

FEATURES

SUMMARY

The function of oxygen

- Supplying oxygen to patients can assist in the treatment of heart head blood-vessel, respiratory system, such as chronic obstructive pneumonia disease, rehabilitation and hypoxia conditions.
- Oxygen could improve body function, especially suit for elderly, pregnant women, physique, students etc. Who got physiological hypoxia. It may also reduce fatigue after heavy manual or mental consumption.

THE SCOPE OF PRODUCTS

For hospital and homecare to supply oxygen to patients.

STRUCTURE

- The product is mainly composed of oxygen making host, flow meter, humidifier.
- Safety plastic shell.
- With time collect function: Display the operation time in LCD.
- With timing power off function.
- High and low pressure alarm function.
- Power loss alarm function.
- Fault self-detection system(Include pressure fault, system cycle fault, compressor fault.).
- The compressor with thermal protector guarantee better security.

- With nebulizer function.
- With real-time detection of SpO₂

SPECIFICATIONS

1. Maximum recommended flow: 5L/min
2. Flow Range: 0.5 ~ 5L/min
3. Change in maximum recommended flow when back pressure of 7kPa is applied: 0.5L/min
4. Oxygen Concentration: 95.5% ~ 87%
5. Maximum Outlet Pressure: 20 ~ 50kPa(2.9psi~7.25psi)
6. Graph showing values of oxygen concentration as a function of flowrate at a nominal outlet pressure of zero (Figure 1):

Oxygen Concentration: %

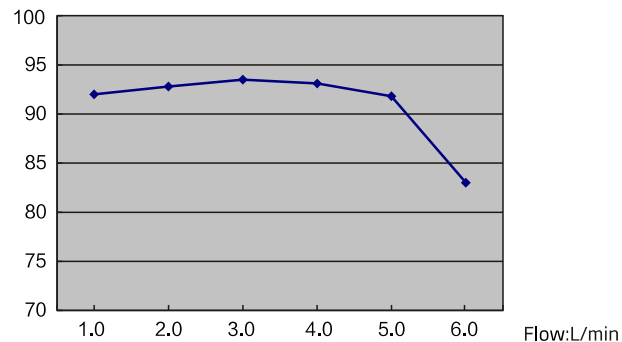

Figure 1

7. Pressure Relief Mechanism Operational at:
250kPa ± 25kPa (36.25psi ± 3.63psi)
8. Noise: 52dB(A) (average)
9. Maximum Nebulization Rate: ≥0.15mL/min
10. Power Supply:
 - AC100V ± 10% AC120V ± 10% AC220V ± 10% AC230V ± 10%
 - 50Hz 60Hz
11. Input Power: 400VA

12. Weight: 18.5kg

13. Dimension: H64cm (25.2") x W24cm (9.4") x D49cm (19.3")

14. Altitude: Up to 1828 meters (6000 ft) above sea level without degradation of concentration levels. From 1828 meters (6000 ft) to 4000meters (13129 ft) below 90% efficiency.

15. Safety system:

Current overload or loose connection, automatic shutdown;
Compressor with abnormal high temperature, automatic shutdown;
High & low pressure alarm function, automatic shutdown;
Compressor error function, automatic shutdown;

16. Minimum Operating Time: 30minutes

17. Electric classification: Class II , type BF application part

18. Work system: work continuously.

19. NORMAL OPERATION CONDITIONS:

Temperature range: 10°C ~ 35°C (50°F ~ 95°F);

Relative humidity: 30% ~ 75%;

Atmosphere pressure: 860hPa ~ 1060hPa(12.47psi ~ 15.37psi);

NOTE: When storage temperature is below 5°C, please keep the equipment in normal working condition for at least 4 hours before using.

20. Temperature at oxygen outlet: ≤46°C

21. Suggestion: The length of nasal oxygen cannula should be less than 15.2 meters and should not be pinched.

22. Transportation and storage conditions :

Temperature range: -20°C ~ +60°C(-4°F ~ +140°F),

Relative humidity: 10% ~ 93%, no condensation,

Atmosphere pressure: 700hPa ~ 1060hPa(10.15psi ~ 15.37psi).

NOTE: Oxygen concentrator should be stored with out intense sunlight, no corrosive gas and in a well ventilated room, avoid jolt and inverted recumbent transport.

HANDLING

UNPACKING

- ⚠️ **NOTE:** Unless the oxygen concentrator is to be used immediately, otherwise it should be stored in the containers until it's being used again.
- Check for any obvious damage to the carton or its contents. If damage is evident, please notify the carrier or local dealer.
 - Remove all loose packing from the carton.
 - Carefully remove all the components from the carton.

INSPECTION

- Examine exterior of the oxygen concentrator for nicks, dents, scratches or other damages. Inspect all components.

STORAGE

- Store the repackaged oxygen concentrator in a dry area.
- Do not place other objects on top of the repackaged concentrator.

OPERATING & INSTALLATION

FEATURE VIEW

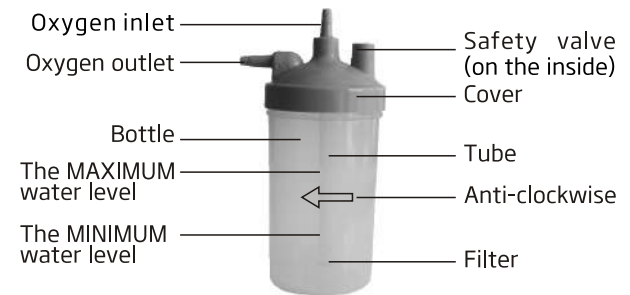
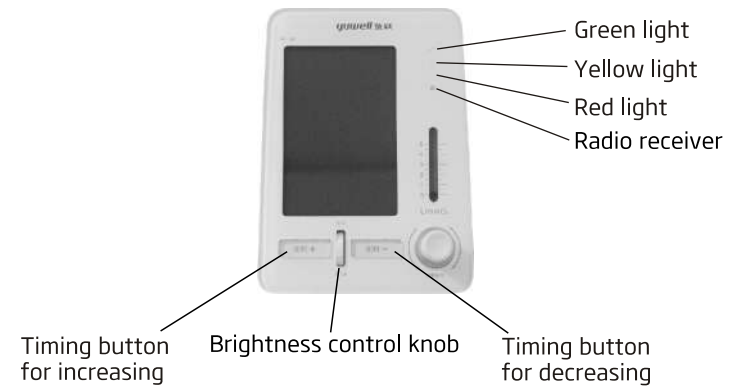
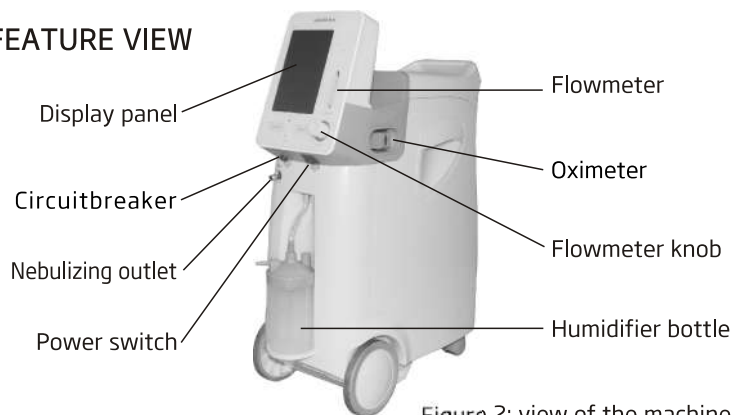

PREPARE WORK

- Unscrew the bottle from the humidifier clockwise. Fill the bottle with pure water (or distilled water) to the level indicated by the manufacturer.
- Screw securely to the bottle back clockwise.
- Plug in: First confirm the power switch of oxygen concentrator is off, then connect the plug .
- Do not use extended power line.

OXYGEN ABSORBING OPERATION

- ▶ Turn the power switch to " | " , the LCD shows "HELLO" , Green, yellow, red indicator all light indicates that the machine is normal. The green indicator lights only 1 second later. 4 seconds later, the LCD shows elapsed time and time setting interface "--H--M", then the machine goes to normal operation.
- ▶ Turn the flowrate knob to require oxygen need (Reed as centre of the black ball). Turn the knob anticlockwise to increase the flowrate, and clockwise to decrease. Meanwhile, humidifier bottle will have air bubble around the sieve core. Then, oxygen comes from the oxygen outlet. (Figure 5)
- ▶ Connect the nasal oxygen cannula to the oxygen outlet of the humidifier, the other end match the patient.

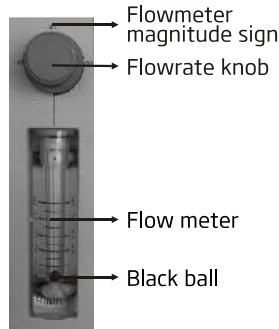

Figure 5

⚠ Note: Adjust the time of absorbing oxygen and the flowrate range according to the doctor's advices.

- ▶ If the humidifier makes continuous sound, it shows that the nasal oxygen cannula jammed, then please clear the pipeline.
- ▶ CAUTION: If the flowrate on the flowmeter ever falls below 0.5L/min, check tubing or accessories for blocked or kinked tubing or a defective humidifier bottle.

NEBULIZING OPERATION

- ▶ Fill proper medicinal liquid in the nebulizing cup (Please follow the doctor's advices for nebulizing time or don't exceed the maximum scale of the nebulizing cup).
- ▶ Upward pull out the nebulizing cover on the nebulizing interface. (Figure 6)

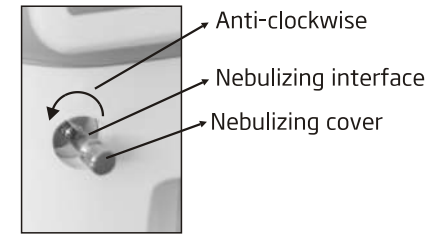



Figure 6

- ▶ Connect the air hose to nebulizing cup and nebulizing interface, then turn on the power of the oxygen concentrator, now can begin nebulizing cure immediately.
- ▶ NOTE: the time for nebulizing should follow the doctor's advices.
- ▶ When nebulizing completing, please turn the nebulizing cover right to nebulizing interface for tightening. When the treatment finishes, please turn off the oxygen concentrator.
- ▶ Screw the nubilizing cover when finished.

Fault detection and alarm signal

- ▶ The machine has detection function as follows
 - (1)Pressure, cycle failure
 - (2)Compressor failure
 - (3)Low oxygen concentrationRemarks: All alarm state of the oxygen concentrator belongs to low priority.
The oxygen sensor starts working after 5 minutes of operation. The indicator shows different colours on the basis of different ranges of oxygen concentration.
Indicator interpretation

Symbol	Statement	Indicator
I/O	System is in good condition: oxygen concentration $\geq 82\%(+3\%)$	Green
	oxygen concentration $< 82\%(+3\%)$	Yellow
	1)Pressure, cycle failure alarm 2)Compressor failure alarm 3)Power loss alarm	Red

- ▶ The alarm signal
 1. When oxygen concentration $\geq 82\%(+3\%)$ the green indicator lights, LCD shows "elapsed time" and "setting time", the machine is in good condition.
 2. When oxygen concentration $< 82\%(+3\%)$ the yellow indicator lights, LCD shows "elapsed time" and "setting time", Please contact the supplier immediately. Users can continue to use, and please ensure that backup oxygen is nearby.

 NOTE: The minimum operating time is 30 minutes

3. Pressure, cycle failure alarm--the red indicator lights with alarm sound, LCD shows "E1 or E2" machine stops working. Please shut down immediately and use backup oxygen, and contact the supplier immediately.
4. Compressor failure alarm--the red indicator lights with alarm sound, LCD shows "E3 or E4", machine stops working. Please shut down immediately and use backup oxygen, and contact the supplier immediately.
5. Power loss alarm--the red indicator lights with alarm sound, no display, no machine working. Please check the power input.

TIME SETTING











This machine has timer function, users can set in the range of 0 ~ 2 hours.

- ▶ When LCD shows "--H--M" it means continuous operation state.
- ▶ Every time press the "+", means runtime increases 1 minute, press for more than 1 .5 seconds for continuous increasing."
- ▶ Every time press the "-", means runtime decreases 1 minute, press for more than 1 .5 seconds for continuous decreasing.
- ▶ The oxygen concentrator will automatically shut down meanwhile LCD shows "00H00M" when time runs out.

TURNNING OFF

Take off nasal oxygen cannula from oxygen outlet first, close power switch, and then cut off power source.

SYMBOLS

Symbol	Description	Symbol	Description
	Alternating current		Consult the manual
	Class II Equipment		Type BF Applied part
	OFF(power, disconnection from the mains)		ON(power, connection to the mains)
	NO SMOKING		KEEP UP
	FRAGILE		KEEP DRY

USING METHOD OF REMOTE CONTROL

- The remote has same functions with the buttons on the machine. (Figure 7)

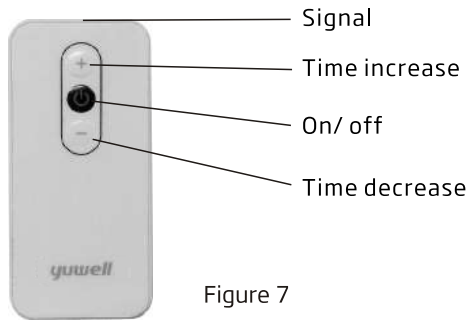

Note: Please use the remote control in front of the receiver.

USING METHOD OF OXIMETER

- Pull out the oximeter from the right side of machine. (Figure 8)
- Flip the tail, then insert a finger. (Figure 9, Figure 10)

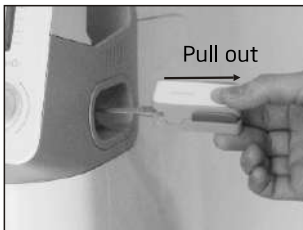

- Read the result in about 10 seconds.

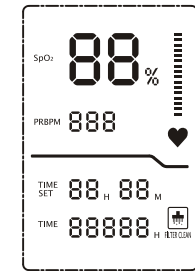

Figure 11

- After monitoring, pull once more the oximeter to replace it.
- Clean & disinfection
- ⚠ Caution: Please turn off the machine before cleaning.
Clean the oximeter once a week with clean and soft cloth which with diluted soapy water.

MAINTENANCE

- ⚠ WARNING: CUT OFF the power supply first. To avoid electrical shock, DO NOT removes cabinet.

CLEANING CABINET

- Clean the cabinet with a mild household cleaner and non-abrasive cloth or sponge at least one time each month.

CLEANING OR REPLACING FILTERS

Please clean and replace the filters in time, it's very important to protect compressor and delay machine's life.

- ⚠ CAUTION: DO NOT operate the concentrator without the filters installed.
- The mesh in filter cleans once half a month. I -stage filter can be taken out of the foreside panel. (Figure12、 Figure13)

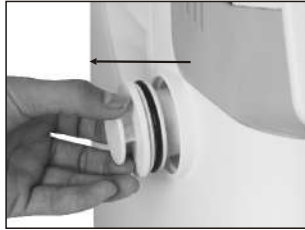

Figure 12



Figure 13

The filter is in the left side of the machine, you can pull out it directly.

- 1) Clean the filters with a vacuum cleaner or wash in warm soapy water and rinse thoroughly.
 - 2) DRY the filters thoroughly before reinstallation.
- **Damage:** Do not operate the concentrator without the filters installed, or while filters are wet. These actions could permanently damage to the concentrator.

CLEANING HUMIDIFIER

- Change the water in humidifier bottle every day.
- Clean humidifier once a week with soapy water and rinse it with a solution of water and vinegar(10:1). Rinse thoroughly with warm water and refill with pure water (or distilled water) to the level shown on the humidifier. (NOTE: No blobs in oxygen tubing)
- Disassembly
 - (1) Screw off the bottle. (Figure14).
 - (2) Take out of the core tube and sieve core. (Figure15).



Figure 14



Figure 15

CLEANING NEBULIZING ASSEMBLY

- Clean the nebulizing assembly after using each time.
- Pull out the air hose, pull the mouthpiece, downward pull the nebulizing cup's cap, empty remained medicinal liquid in the nebulizing cup, then wash the air hose, mouthpiece, nebulizing cup's cap, nebulizing baffle, nebulizing cup, ripple tube, T-piece, etc , with pure water or immerge them in warm water for about 15 minutes(Figure 16). In order to wash them properly, you may add some vinegar in water.
- ⊙ NOTE: DO NOT cook the accessories above for wash or wash them with boiled water, in case they'll distort when heating.
- After finishing washing you must dry all the accessories before storing.

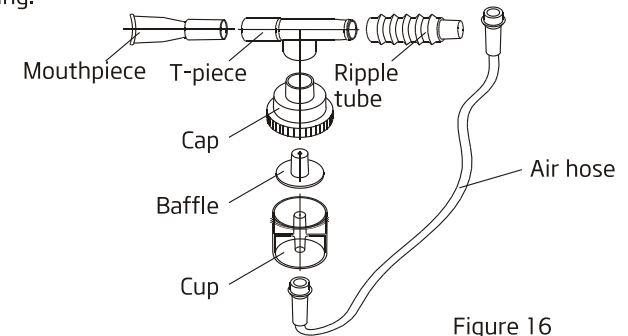

Figure 16

TROUBLE SHOOTING GUIDE

Symptom	Probable reasons	Solution	Remark
When power has been interrupted, concentrator alarms , red light illuminates , but no display and not work.	1)Power cord NOT plugged in	1)Insert plug into outlet	Repairs by qualified personnel
	2)No power at outlet	2)Use normal power	
	3)The power is no sufficient at outlet	3)Do not use extended cord	
	4)Breaker reset button raised	4)Press it. If this state continues, stop using the concentrator and get in touch with the supplier at once.	
Concentrator is working, but oxygen from outlet is little or no	1)Humidifier leaked	1)Reinstall and tighten it	
	2)Safety valve of humidifier opens	2)Safety valve restoration	
	3)The connection of the tubes loosened	3)Insert tubes	
	4)The nasal cannula kinked or blocked	4)Replace it	
Concentrator is working, yellow light illuminate	1)oxygen concentration < 82%	1)Clean or replace the filter	
	2)Oxygen flow rate is more than 5L/min	2)Compiled doctor's advice, turn the flowmeter to the given value	
	3)If this state continues, you may continue to use the concentrator. Contact the supplier at once.		
Concentrator is alarm and not working, the red light illuminate, the display screen shows "E1"	1)Low cycle pressure failure	1)Clean or replace the stage filter	
	2)If this state continues, stop using the concentrator and get in touch with the supplier at once.		

Symptom	Probable reasons	Solution	Remark
Concentrator is alarm and not working, the red light illuminate, the display screen shows "E2"	1)High cycle pressure failure	1)Stop using the concentrator and get in touch with the supplier at once	
Concentrator is alarm and not working, the red light illuminate, the display screen shows "E3"	1)Compressor circuit is open circuit	1)Stop using the concentrator and get in touch with the supplier at once	
Concentrator is alarm and not working, the red light illuminate, the display screen shows "E4"	1)Compressor circuit is short circuit	1)Stop using the concentrator and get in touch with the supplier at once	
The nasal cannula has more mirage or blobs	1)It's not ventilate completely around machine, so operating temperature is too high	1)Make sure the machine is at least 10cm away from the walls, other jam or heater	
	2)Temperature of the water added in humidifier bottle is overhigh	2)Add cold water in bottle, but don't add overhot water	
	3)The water added in humidifier bottle is too much	3)Make sure the water stays between the maximum and minimum of the water scale	
	4)The machine stops suddenly during breathing oxygen	4)Stop breathing oxygen immediately. Restart the machine to eject the hydrosphere	
	5)The machine stops suddenly when folding the nasal cannula	5)Smooth the nasal cannula	
	6)Fan inside the machine can't run or running rate turns slow make the operating temperature overhigh	6)a.Take out the eyewinker that lock the fan 6)b. Replace it	
			Repairs by qualified personnel

Symptom	Probable reasons	Solution	Remark
The nebulizer doesn't run	1)Check nebulizer is distortional or not if it was disinfected.	1)Replace it	
	2)Check the air hose whether it is bended or not	2)Ensure that it isn't bended and airflow is flowed smoothly when it is used	
	3)Check whether medication was used up or not	3)Add appropriate amount medicine to cup	
	4)Check the nebulizer is fixed properly or not	4)Fix it according the method of nebulizer's fixing	
Show result of SpO2 or Pulse rate is not stable	1)Some foreign object shielded the probe from light	1)Check the probe and clean it	
	2)Finger is shaking or body is moving	2)Stay still	
	3)Finger has not inserted properly	3)Make sure the center of finger is matched the oximeter	
	4)Glare	4)Shield the oximeter with opaque goods	
	5)Pulse rate is cyclic swing	5)Arhythmia	
	6)Please do not use the oximeter and contact with the supplier		
Oximeter does not show result correctly	1)Finger has not inserted properly	1)Make sure the center of finger is matched the oximeter	
	2)For fingers with nail-polish	2)Remove nail-polish	
	3)SpO2 is too low or pulse rate is irregular	3)Test for several times to check the machine. Or please see a doctor	
	4)If the problem continuous, please contact the supplier		
Remote control doesn't work	1)The remote control is not in effective range	1)Please use the remote control in effective range	
	2)Low power	3)Please change with new batteries	

⚠ If you have all other problems, TURN OFF the concentrator first, use your reserve oxygen supply (if provided) and contact dealer or manufacturer immediately.

DISASSEMBLY (CUT OFF the power supply first)

CUT OFF THE POWER SUPPLY FIRST

- ▶ Turn the power switch to the "0" position and unplug it.

DISASSEMBLE THE TOP COVER

- ▶ Unscrew 2 fixing screws on the back of the machine. (Figure 17)
- ▶ Press the central of the upper cover and the handle lift up, then remove the cover. (Figure 18)

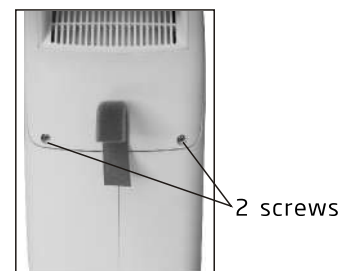

Figure 17



Figure 18

DISASSEMBLE THE PANEL

- ▶ Unscrew the 4 fixing screws which connect the back of the panel and both sides of the panel, then push the panel. (Figure 19)
- ▶ Pull off the tube which connects with the oxygen outlet, then take out the panel. (Figure 20)

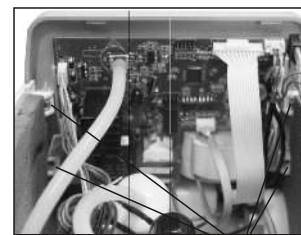

Figure 19

4 screws



Figure 20

connecting tube

DISASSEMBLE THE FRONT PANEL

- Unscrew 4 fixing screws at the bottom of the front panel. (Figure 21)
- Pull off the tube of nebulizer. (Figure 22)
- Unscrew 4 fixing screws at the top of the front panel, then take out the front panel. (Figure 22)



4 screws
Figure 21

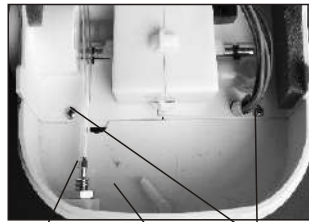

Tube of nebulizer
The front panel 2 screws
Figure 22

- The oxygen concentrator to the right and downwards, unscrew 4 fixing screws in the bottom. (Figure 24)



Figure 24
4 screws

DISASSEMBLE THE LEFT CABINET

- Pull out the filter from the left side of the machine. (Figure 23)
- Cut the two buckles which for fixing the rod of pump. (Figure 23)
- Remove the filter. (Figure 23)
- Remove the rod of pump. (Figure 23)

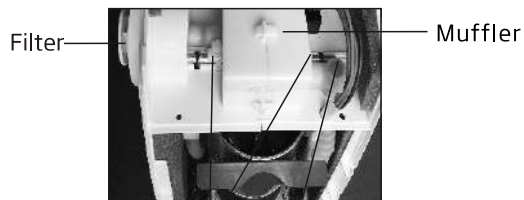

Filter
Muffler
Two buckles
Rod of pump
Figure 23

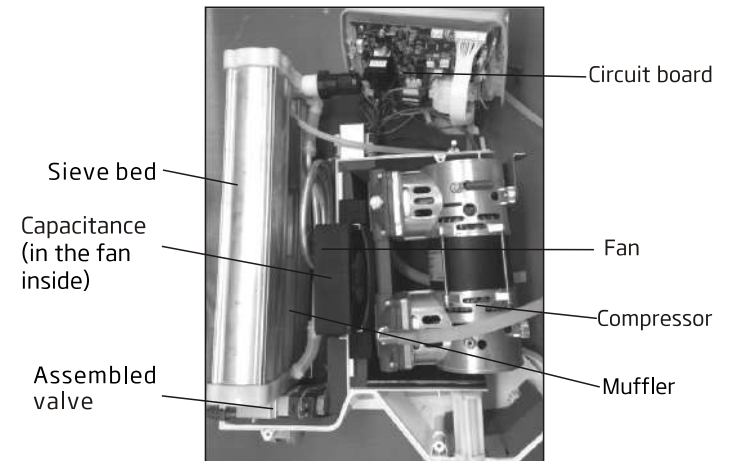
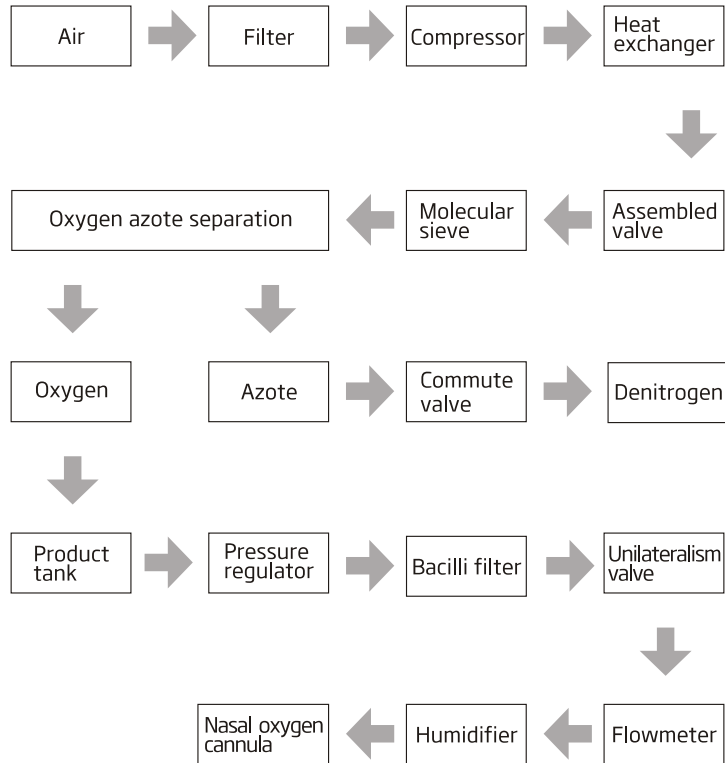

Figure 25

OTHER ATTENTION ITEMS

GAS PASS OPERATION SKETCH MAP



ELECTRICAL RATIONALE

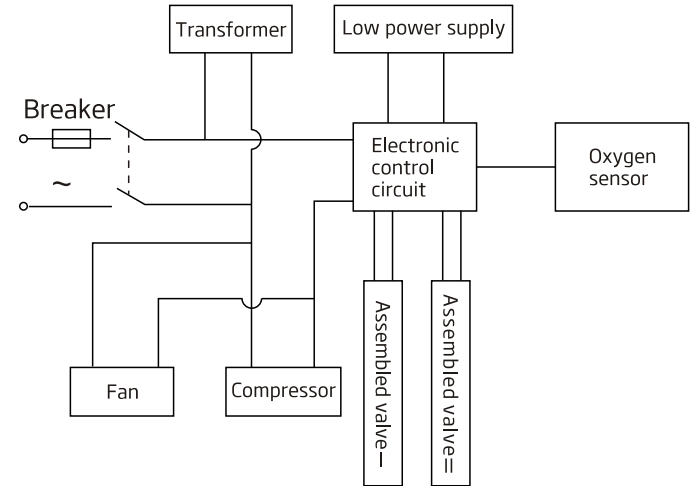

ACCESSORIES LIST

1. Nasal oxygen cannula	1 set
2. User's and Technical Manual	1 piece
3. Filter core	1 set
4. Nebulizer	1 set
5. Warranty card	1 piece
6. Remote control	1 set

All specifications and product configurations are subject to change without notification.

JIANGSU YUYUE MEDICAL EQUIPMENT & SUPPLY CO., LTD
 江苏鱼跃医疗设备股份有限公司
 吴明